

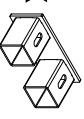









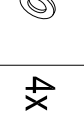

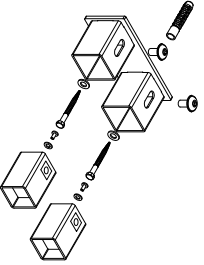

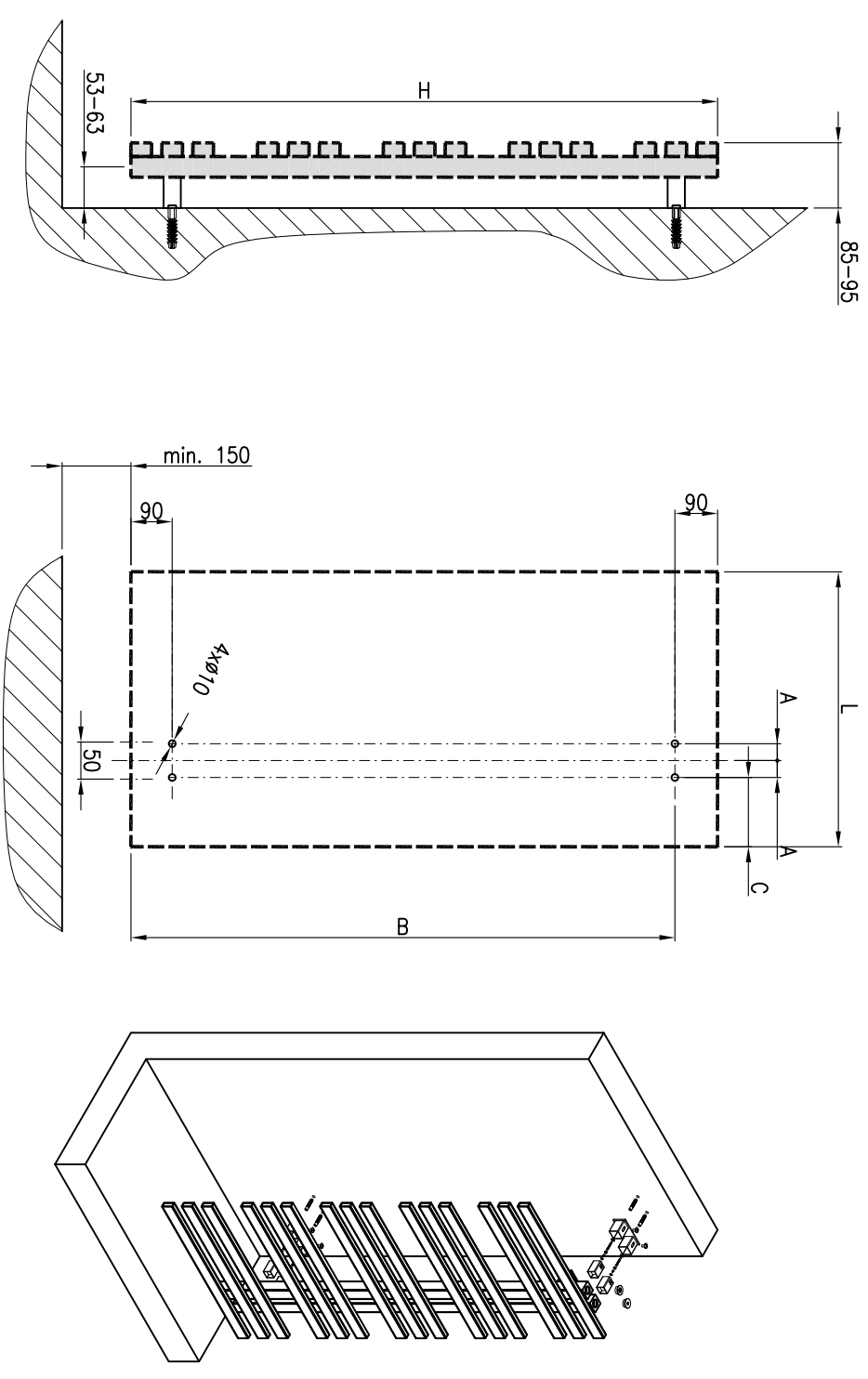
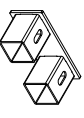

2X		4X		4X		4X		
4X		4X		4X		4X		

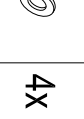
H/L [mm]	A [mm]	B [mm]	C [mm]
1215/600	25	1125	100
1647/600	25	1557	100

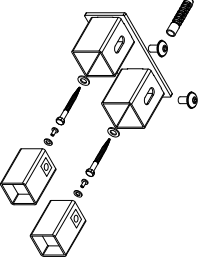

2X		4X		4X		4X		
4X		4X		4X		4X		

H/L [mm]	A [mm]	B [mm]	C [mm]
1215/600	25	1125	100
1647/600	25	1557	100

